

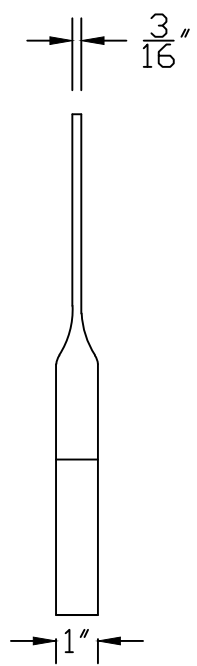

ORLANDO
 4677 LB Mcleod Rd. Suite B
 Orlando, FL 32811
 Ph: 407-649-7767
 Email: usgutterproducts.com

FORT LAUDERDALE
 3605 NE 5th Avenue
 Oakland Park, FL 33334
 Ph: 954-309-6614

5" RAFTER MOUNT 3/16"x1" BAR HANGER



FRONT VIEW

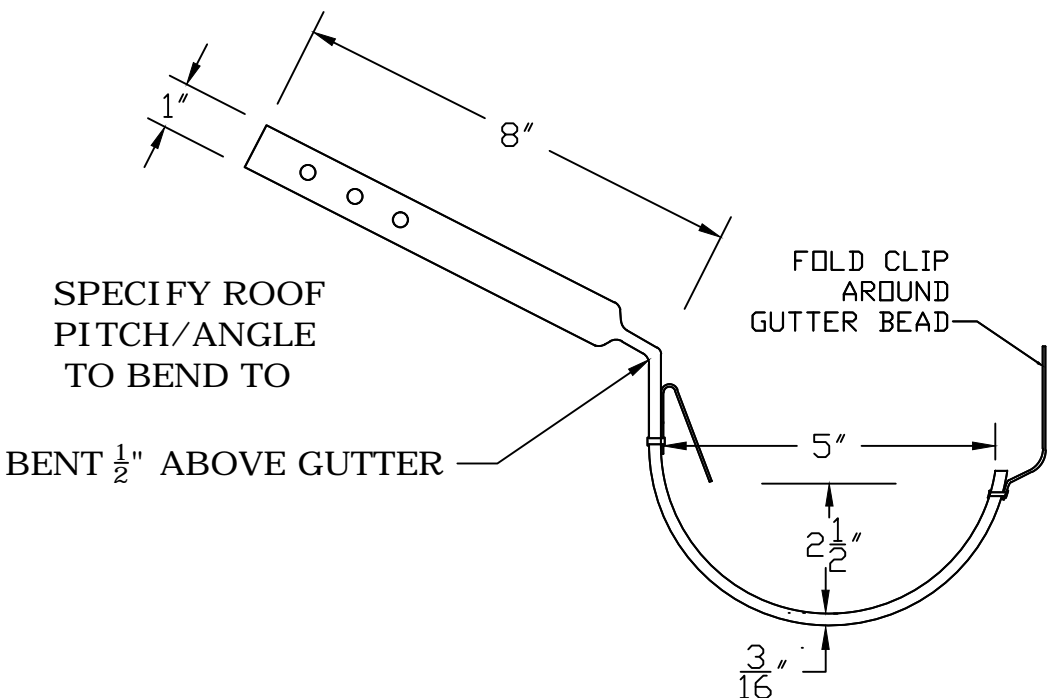

SIDE VIEW

MATERIAL; COPPER, ALUMINUM, STAINLESS STEEL, GALVANIZED

Job Name	
Material	
Color	
Notes	
Approved By	